

Padlocks

TESA

ASSA ABLOY



Padlocks that shut lots of advantages



When you think of safety, think of TESA. And now we give you yet another reason for doing so: our new range of padlocks. A whole series which helps us to keep ahead of all the other trademarks because our padlocks not only meet

the most stringent requirements regarding safety, resistance and durability but they also provide you with advantages that nobody else is able to provide. Once again, TESA is a reference point in terms of security.

Internal security

Still using a padlock with a flat key? The external appearance of a padlock is often considered to be more important than what is concealed within. That is why, although many padlocks have a robust external appearance, nobody had hitherto thought of using one of the best safety weapons existing for the inside: cylinders for flat keys! TESA has done this and provides you with padlocks which are as secure on the outside as on the inside.



Masterkeying

Masterkeying enables the same key to be used in different padlocks, irrespective of the fact that each of them has its own key. Thus, maximum comfort and safety is obtained, because a single master key is capable of opening all the padlocks you wish. For offices, houses and companies of different sizes, masterkeying enables you to increase security by reducing the number of keys to be used, and to establish access control.



TESA guarantees

Quality is assured when you buy TESA products. Here at TESA the very latest technology is used by a creative workforce organised within a management framework which has obtained not only the ISO 9001 quality control guarantee but also the environmental certificate ISO 14001 and which delivers an on-going commitment to the very highest of health and safety standards at work.

Interchangeability

The only padlock in the world which is adapted to your needs. Depending on your security needs or on the goods you wish to protect, our padlocks give you the chance to choose the cylinder you prefer for your padlock and to change it when you wish. In this way you choose the degree of security you desire at any given time, because we give you the chance to choose from among the wide range of TESA cylinders.



Electronic cylinders for access control

Access points which nobody believed could be controlled now under control. The possibility of exchanging cylinders gives a new dimension to padlocks: the chance to insert an electronic cylinder for access control in your padlock and therefore to know who has entered this access point, when and at what exact time. In this way, you can choose to integrate any access point within a comprehensive locking plan, even though the only way of locking it may be by using a padlock. Thus, you will not leave a single access point outside the security system you design.



Here are the manufacturing specifications of each of our padlocks. A range from which you will always be able to find a made-to-measure key, because they have been developed in order to provide a wide variety of performance features: ranging from padlocks which comply with the strictest safety parameters to those which offer the utmost resistance against corrosion and resistance to adverse weather conditions, to those designed to be used within an access control system.



Padlocks / series	Features	Weatherproof	Masterkeying	Electronic cylinder	Key alike	Security
Titanium series	Weatherproof	*****	•	•	•	*****
Titanium series	High security double ball locking mechanism	****	•	•	•	*****
Titanium series	Strict requirements in terms of security and access control	****	•	•	•	*****
High security series	Security ball locking mechanism	****	•	•	•	*****
High security series	Strict requirements in terms of security and access control	****	•	•	•	*****
Security series	Security ball locking mechanism	****			•	****
Security series	Safety applications	****			•	****
Stainless steel series	High security double ball locking mechanism	*****			•	****
Stainless steel series	Very serious corrosion condition	*****			•	****
Changeable stainless series	Double security locking mechanism	*****	•		•	*****
Changeable stainless series	Very serious corrosion condition	*****	•		•	*****
Brass series	Inox spring and varnished casing	****			•	***
Brass series	Residential	****			•	***
Changeable brass series	Double security locking mechanism	****	•		•	****
Changeable brass series	Residential	****	•		•	****
Hermetic series	Hytrel covering	*****				***
Hermetic series	Weatherproof	*****				***
Combination series (chrome)	Double security locking mechanism (CPV50)	****				****
Combination series (chrome)	Applications which require combination padlock	****				****
Combination series (brass)	Brass combination	***				***
Combination series (brass)	Applications which require combination padlock	***				***

Padlocks

Brass series

- » Double security locking mechanism.
- » Hardened steel shackle.
- » Varnished brass casing for better protection.
- » Stainless steel springs.
- » Key alike.
- » Key to a certain number

Reference	Packaging	A	B	C	D
CLV15LTK4	Visual	15	31	10	2
CL20LT	In box	20	35	11	3
CL20LTKA	In box	20	35	11	3
CL20LTKA	In box	20	35	11	3
CL2025LT	In box	20	48	25	3
CL2025LTKA	In box	20	48	25	3
CL25LT	In box	25	44	14	4
CL25LTKA	In box	25	44	14	4
CL2530LT	In box	25	60	30	4
CL2530LTKA	In box	25	60	30	4
CL30LT	In box	30	50	18	5
CL30LTKA	In box	30	50	18	5
CL3040LT	In box	30	75	40	5
CL3040LTKA	In box	30	75	40	5
CL40LT	In box	40	63	23	6
CL40LTKA	In box	40	63	23	6
CL4055LT	In box	40	95	55	6,5
CL4055LTKA	In box	40	95	55	6,5
CL50LT	In box	50	78	29	8
CL50LTKA	In box	50	78	29	8
CL5070LT	In box	50	120	70	8
CL5070LTKA	In box	50	120	70	8
CL60LT	In box	60	84	34	9
CL60LTKA	In box	60	84	34	9

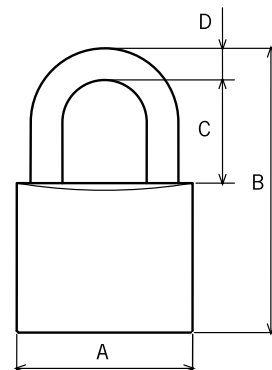

Changeable brass series

- » Equipment with TESA cylinder system.
- » Double security locking mechanism.
- » Hardened steel shackle.
- » Varnished brass casing for better protection.
- » Possibility of keys alike and masterkeying.
- » Stainless steel springs.

Reference	Packaging	A	B	C	D
CL55SCIL	In box	55	94	34	9
CL55IPS	In box	55	94	34	9
CL55TE6LT	In box	55	94	34	9
CL55TX80LT	In box	55	94	34	9
CL55T10LT	In box	55	94	34	9
CL55T12LT	In box	55	94	34	9
CL55T60LT	In box	55	94	34	9
CL55T80LT	In box	55	94	34	9
CL555030LT	In box	55	94	34	9



Padlocks

Stainless steel series

- » High security double ball locking mechanisms.
- » Stainless steel shackle.
- » Chrome brass casing with extraordinary resistance to corrosion.
- » Possibility of keys alike and key to a certain number.
- » Possibility of long shackle.
- » Stainless steel springs.

Reference	Packaging	A	B	C	D
CL30CR	In box	30	50	18	5
CL30CRKA	In box	30	50	18	5
CL3040CR	In box	30	75	40	5
CL3040CRKA	In box	30	75	40	5
CL40CR	In box	40	63	23	6
CL40CRKA	In box	40	63	23	6
CL4055CR	In box	40	105	55	7
CL4055CRKA	In box	40	105	55	7
CL50CR	In box	50	78	29	8
CL50CRKA	In box	50	78	29	8
CL5070CR	In box	50	120	70	9
CL5070CRKA	In box	50	120	70	9



Changeable stainless steel series

- » Double security locking mechanism.
- » Stainless steel shackle.
- » Chrome brass casing with extraordinary resistance to corrosion.
- » Possibility of keys alike and masterkeying.
- » Stainless steel springs.
- » Possibility of long shackle.

Reference	Packaging	A	B	C	D
CL55CRSCIL	In box	55	94	34	9
CL55ALCRSCIL	In box	55	130	70	9
CL55ALTE5CR	In box	55	130	70	9
CL55ALTE6CR	In box	55	130	70	9
CL55IPSCR	In box	55	94	34	9
CL55TE6CR	In box	55	94	34	9
CL55TK1V2CR	In box	55	94	34	9
CL55TX80CR	In box	55	94	34	9
CL55T10CR	In box	55	94	34	9
CL55T12CR	In box	55	94	34	9
CL55T60CR	In box	55	94	34	9
CL55T80CR	In box	55	94	34	9
CL555030CR	In box	55	94	34	9

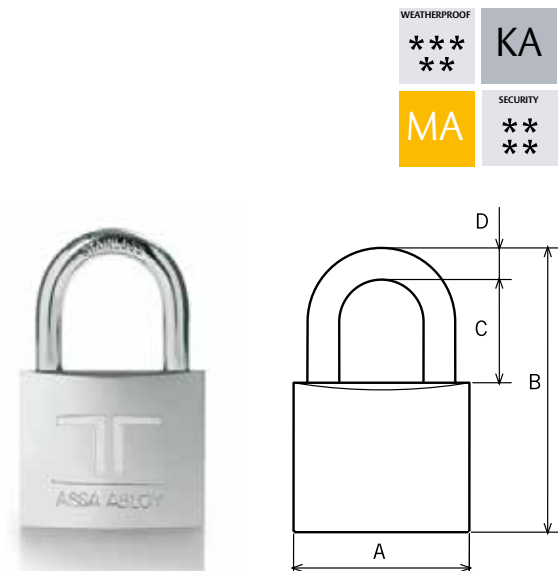

Padlocks

Hermetic series

- » Hermetic weatherproof padlock.
- » Highly resistant in adverse conditions.
- » Hytrel covering.
- » Stainless steel springs.
- » Double security locking mechanism.
- » Hardened steel shackle.
- » Brass casing

Reference	Colour	A	B	C	D
CHV50A	Azul	50	78	29	8
CHV50R	Rojo	50	78	29	8

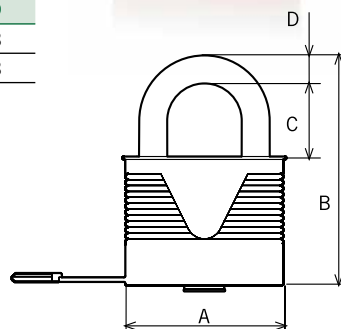
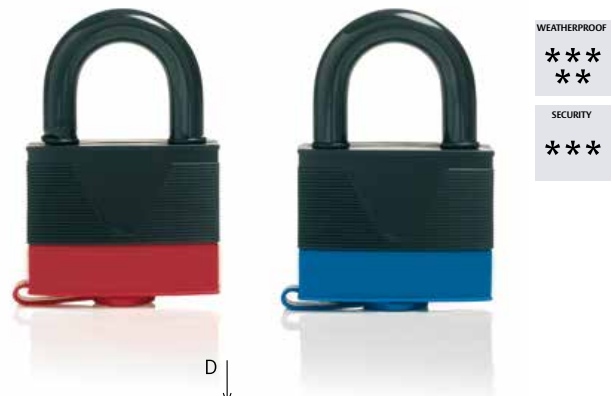

Combination series

- » Programmable padlock.
- » Combination may be changed by the user themselves.
- » Stainless steel springs.
- » Coloured protection cover in CPV28.
- » Double security locking mechanism in CPV50.
- » Chrome brass casing with extraordinary resistance to corrosion.
- » Stainless steel shackle in CPV50.

Reference	Packaging	A	B	C	D
CPV50CR	Visual	55	78	28	8
CPV38LT	Visual	38	85	30	6
CPV28N	Visual	24	58	23	3
CPV28V	Visual	24	58	23	3



CPV50CR

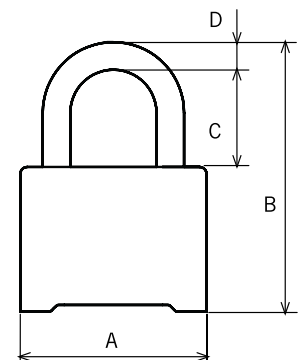

CPV38N



CPV38V

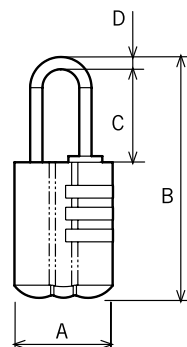

CPV38LT

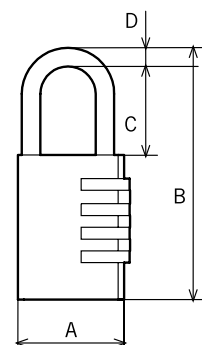

Padlocks

Security series

- » Security padlock.
- » Varnished brass casing for better protection.
- » Hardened chrome steel shackle with automatic opening.
- » Security ball locking mechanism.



Reference	Packaging	A	B	C	D	E
CSCH70LT	In box	70	48	14	12	20

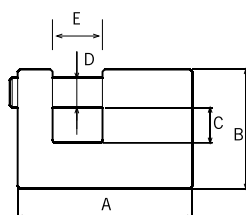

High security series

- » High security padlock.
- » Standard or flat key cylinder.
- » Hardened chrome steel casing.
- » Major masterkeying possibilities.
- » Visual presentation.
- » Security ball locking mechanism.
- » Hardened chrome steel shackle.
- » Cylinder protection system.

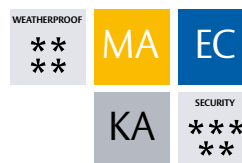

Reference	Packaging	A	B	C	D	E
CSIPS	In box	90	80	18	12	41
CSSCIL	In box	90	80	18	12	41
CSTE	In box	90	80	18	12	41
CSTX80	In box	90	80	18	12	41
CST10	In box	90	80	18	12	41
CST12	In box	90	80	18	12	41
CST60	In box	90	80	18	12	41
CST80	In box	90	80	18	12	41

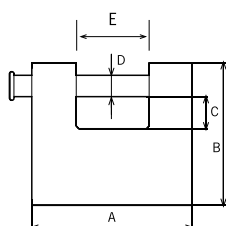

Padlocks

Titanium series

- » High security padlock.
- » High resistance double security ball locking mechanism.
- » All types of masterkeying.
- » Hardened chrome steel casing and shackle.
- » Hytrel protective covering.
- » Cylinder protection system.
- » Non-removable key with open padlock.
- » Anti-guillotine, anti-lever model CT60APCR model and anti-extraction.
- » Maximum security reversible key cylinders.

Reference	Packaging	A	B	C	D
CT60SCIL	In box	60	93	23	11
CT60TK100CR	In box	60	93	23	11
CT60TX80CR	In box	60	93	23	11
CT60T10CR	In box	60	93	23	11
CT60T12CR	In box	60	93	23	11
CT60T60CR	In box	60	93	23	11
CT60T80CR	In box	60	93	23	11

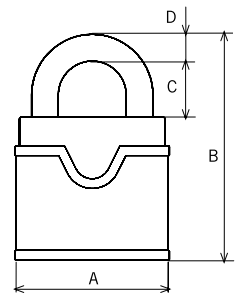

Titanium stainless steel series

- » High security padlock.
- » High resistance double security ball locking mechanism.
- » All types of masterkeying.
- » Stainless steel casing and shackle.
- » Hytrel protective covering.
- » Cylinder protection system.
- » Non-removable key with open padlock.
- » Maximum security reversible key cylinders.

Reference	Packaging	A	B	C	D
CT60TK100IS	In box	60	93	23	11
CT60TX80IS	In box	60	93	23	11
CT60T12IS	In box	60	93	23	11
CT60T60IS	In box	60	93	23	11
CT60T80IS	In box	60	93	23	11



Titanium series, protected shackle

Reference	Packaging	A	B	C	D
CT60APT60CR	In box	60	93	23	11
CT60APT80CR	In box	60	93	23	11
CT60APT80CR	In box	60	93	23	11
CT60APT80CR	In box	60	93	23	11
CT60APT10CR	In box	60	93	23	11
CT60APT12CR	In box	60	93	23	11

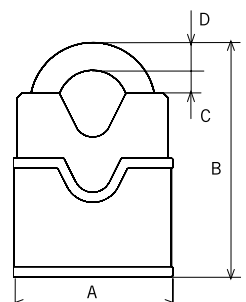



ASSA ABLOY

Talleres de Escoriaza, S.A.U.
Barrio Ventas, 35 • E-20305 Irun • SPAIN
Tel.: +34 943 669 100 • Fax: +34 943 622 189
www.tesa.es

ASSA ABLOY is the global leader in door opening solutions,
dedicated to satisfying end-user needs for security, safety and convenience.